



OPERATION CONDITION	Ambient Temp.: 5-38°C, Water Supply Temp.: 5-32°C
	Water Supply Pressure: 0.07-0.55MPa (0.7-5.5bar)
	Voltage Range: 198-242V.

*We reserve the right to make changes in specifications and design without prior notice.

1. Install the ice maker properly in accordance with the instructions on location, water supply/drain connections and electrical connections stated in the instructions and installation manuals provided.
2. The ice production depends on the ambient and water temperatures.
3. Product Code: M093-C371. 

ITEM	ICE MATE RHOMBIC ICE MAKER
MODEL	SRM-450WB-S 
POWER SUPPLY	1 Phase 220V 50Hz
RATED AMPERAGE	9.6A (AT.32°C, WT.21°C)
STARTING AMPERAGE	45.7A
ELECTRICAL CONSUMPTION	1800W (AT.32°C, WT.21°C)
POWER FACTOR	85%
POWER CAPACITY	Min 2.75kVA (85A)
ICE PRODUCTION PER 24h	Approx.450kg/day (AT.10°C, WT.10°C) Approx.440kg/day (AT.21°C, WT.15°C) Approx.430kg/day (AT.32°C, WT.21°C)
ICE WATER CONSUMPTION PER 24h	Approx.0.48m ³ /day (AT.10°C, WT.10°C) Approx.0.47m ³ /day (AT.21°C, WT.15°C) Approx.0.46m ³ /day (AT.32°C, WT.21°C)
CONDENSATION WATER CONSUMPTION PER 24h	Approx.2.30m ³ /day (AT.10°C, WT.10°C) Approx.2.80m ³ /day (AT.21°C, WT.15°C) Approx.4.00m ³ /day (AT.32°C, WT.21°C)
 SHAPE OF ICE	Dice:22*22*22
FREEZE CYCLE TIME	Approx.12min (AT.21°C, WT.15°C)
ICE PRODUCTION PER CYCLE	Approx.4.25kg/440pcs (AT.21°C, WT.15°C)
OUTSIDE DIMENSIONS	760mm (W) x 620mm (D) x 760mm (H)
EXTERIOR	Stainless Steel, Galvanized Steel (Rear)
INSULATION	Polyurethane Foam
INSULATION FOAM BLOWING AGENT	Cyclopentane
CONNECTIONS - ELECTRIC	Y-type Connection (With Plug)
CONNECTIONS - WATER SUPPLY	Inlet G3/4 Cond. Inlet Rc1/2 (connected at rear side)
CONNECTIONS - DRAIN	Outlet I.D.ø22mm Outlet Rc1/2 (connected at rear side)
ICE MAKING SYSTEM	Vertical Evap., Jet Spray System On one side
HARVESTING SYSTEM	Hot Gas Defrost and Gravity
COMPRESSOR	Hermetic
CONDENSER	Water cooled, casing-type
EVAPORATOR	Vertical, Copper Tube and Sheet (Surface Plating)
REFRIGERANT CONTROL	Expansion valve
REFRIGERANT	R404A/800g
ICE MAKING CONTROL SYSTEM	Float Switch
HARVESTING CONTROL SYSTEM	Ice Guide, Timer
BIN CONTROL SYSTEM	Bin Control Switch
ELECTRICAL PROTECTION	6.3A FUSE
ICE MAKER PROTECTION	Interlock by Controller Board
COMPRESSOR PROTECTION	Auto-reset Overload Protector
REFRIGERANT CIRCUIT PROTECTION	Auto-reset High Pressure Control Switch
WEIGHT	Net: 95kg, Gross: 105kg
PACKAGE	Pallet+Carton: 865mm(W)x720mm(D)x945mm(H)
ACCESSORIES	Instruction Manual, Inlet pipe, Drain pipe, Universal Brace(2), Bolt(2)

*We reserve the right to make changes in specifications and design without prior notice.

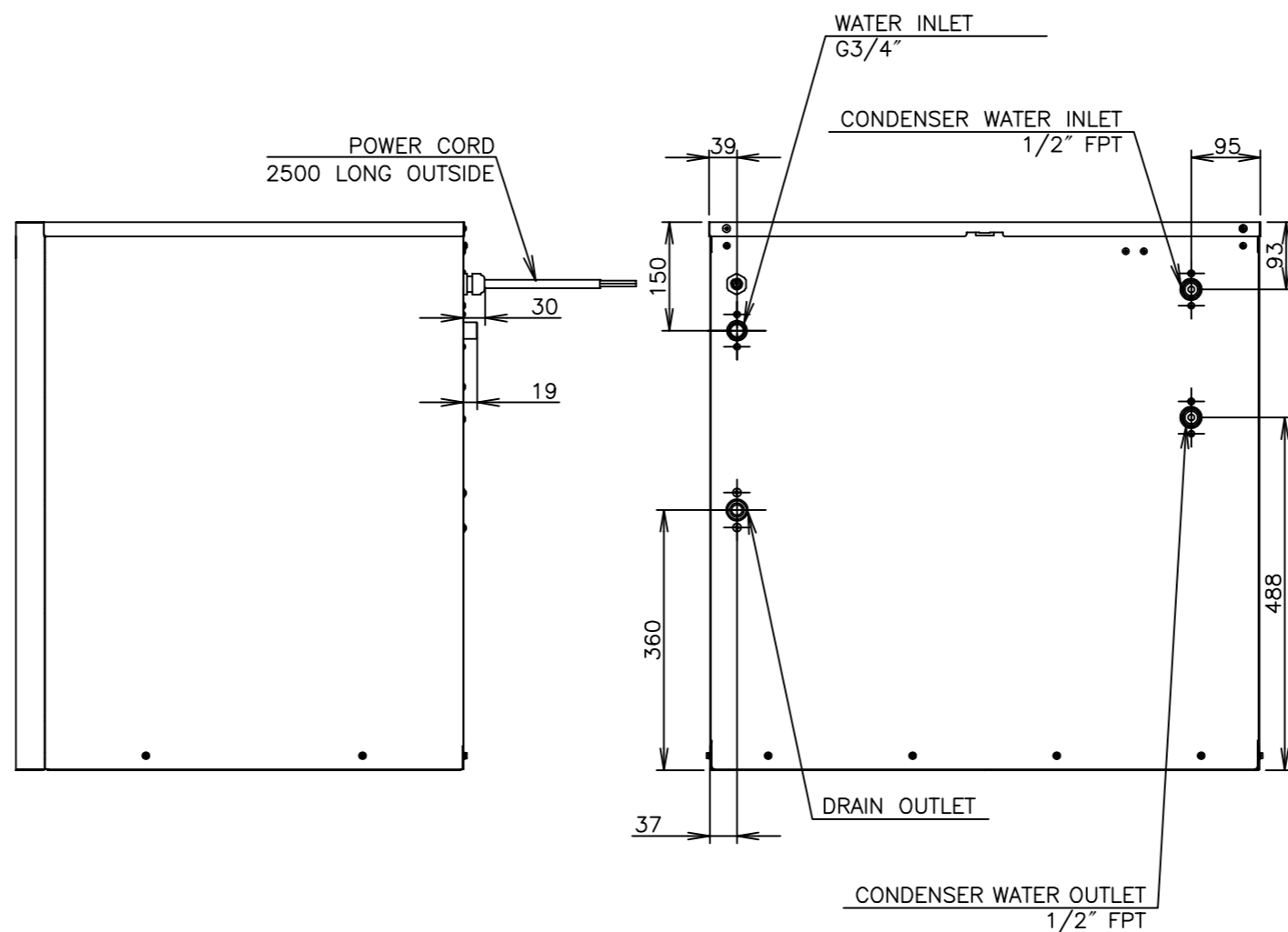
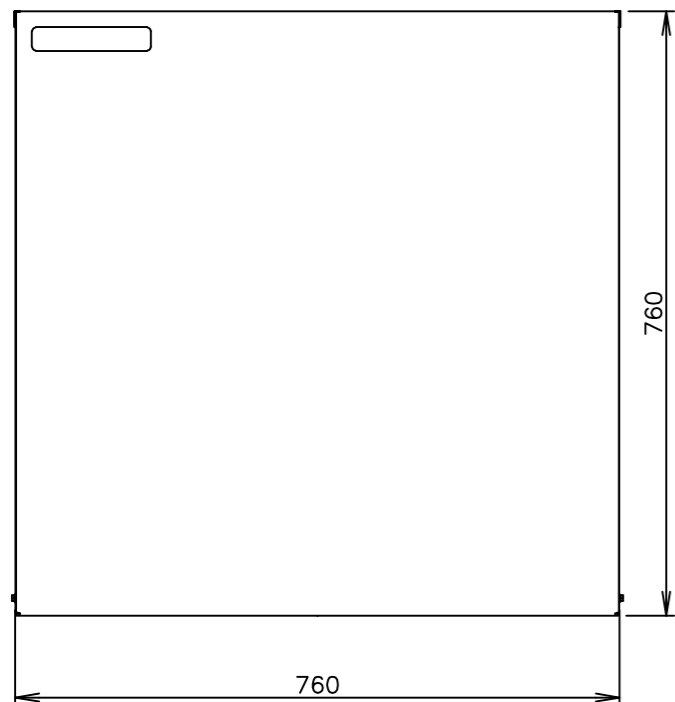
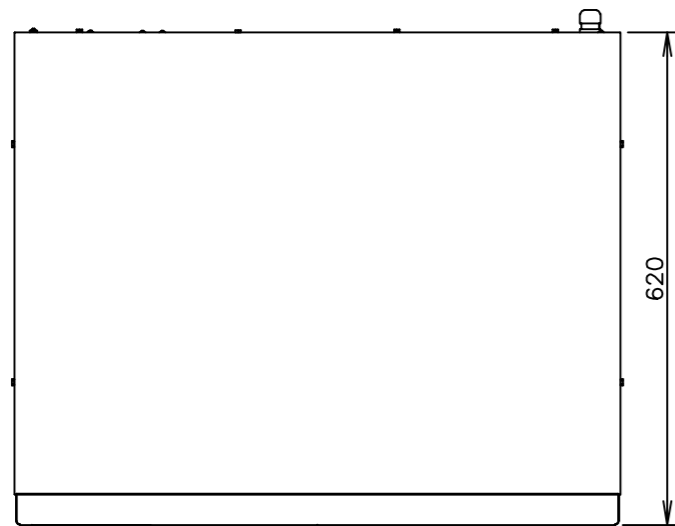

ICE MATE RHOMBIC ICE MAKER (MODULAR TYPE) SRM-450WB-S

APPROVED TORIHATA	CHECKED TORIHATA	DESIGNED JIA	DRAWN JIA	SCALE 1/10	TRIGONOMETRY
TORIHATA	BAO		2024.11.26	DATE 2024.06.24	DRAWING NO. D39464
APPROVED	DESIGNED	SYMBOL	DATE		SYMBOL 